

Use and Care Guide

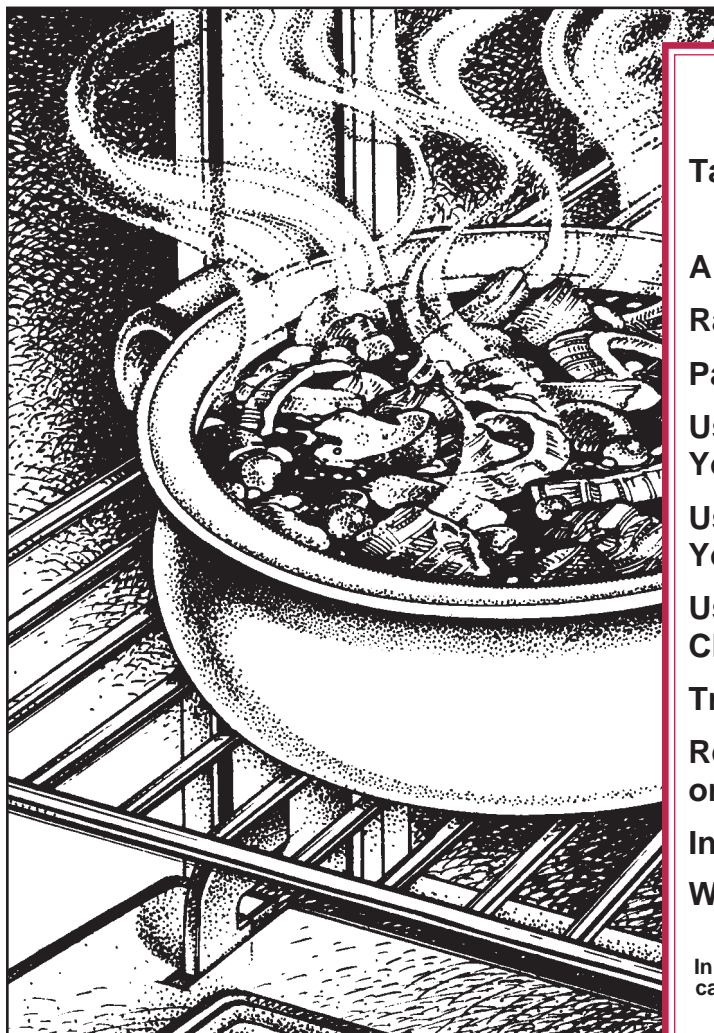

KitchenAid[®]

Table of Contents (complete)	2
A Note to You	3
Range Safety	4-6
Parts and Features	7
Using and Caring for Your Cooktop	11
Using and Caring for Your Oven	17
Using the Self- Cleaning Cycle	44
Troubleshooting	48
Requesting Assistance or Service	50
Index	55
Warranty	56

In the U.S.A. for assistance or service,
call the Consumer Assistance Center:

1-800-422-1230

In Canada for assistance or service,
see page 51.

KITCHENAID[®] Electric Range

PART NO. 9752956

**Models: KESC300 YKESC300
KERC600 YKERC600**

Table of Contents

A Note to You	3	Cooking tips	28
Range Safety	4-6	Adjusting the oven temperature	33
Parts and Features	7	Broiling	35
Feature locations	7	Timed cooking	38
The oven vent	9	Cleaning your oven and controls	41
The storage drawer	9	Using and replacing the oven light(s)	43
The anti-tip bracket	10	Using the Self-Cleaning Cycle	44
Using and Caring for Your Cooktop	11	Before you start	44
Using the surface cooking areas	11	Before setting the controls	45
Cookware tips	13	Setting the controls	45
Energy saving tips	14	For best cleaning results	47
Caring for your cooktop	14	How the cycle works	47
Using and replacing the surface light	16	Troubleshooting	48
Using and Caring for Your Oven	17	Requesting Assistance or Service	50
Using the electronic oven control	17	Index	55
Setting the clock	25	Warranty	56
Using the timer	25		
Baking or roasting	27		

A Note to You

Thank you for buying a KITCHENAID* appliance!

KitchenAid designs the best tools for the most important room in your house. To ensure that you enjoy many years of trouble-free operation, we developed this Use and Care guide. It contains valuable information concerning how to operate and maintain your new appliance properly and safely. Please read it carefully.

Also, please complete and mail the enclosed Product Registration Card.

In the U.S.A.

For assistance or service

Call the Consumer Assistance Center toll free **1-800-422-1230**

Throughout Canada for assistance

Call the Consumer Assistance Centre toll free **1-800-461-5681**
8:30 a.m. – 6 p.m. (EST)

Throughout Canada for service see page 51

If you need assistance or service, first see the “Troubleshooting” section of this book. After checking “Troubleshooting,” additional help can be found by checking the “Requesting Assistance or Service” section, or by calling one of the telephone numbers above.

When calling, you will need to know your appliance’s complete model number and serial number. You can find this information on the model and serial number label/plate (see diagrams in the “Parts and Features” section).

Keep this book and the sales slip together in a safe place for future reference. **You must provide proof of purchase or installation date for in-warranty service.**

Model Number _____ Builder/Dealer Name _____

Serial Number _____ Address _____

Date Installed _____ Phone _____

⚠ WARNING

Tip Over Hazard

A child or adult can tip the range and be killed.
Connect anti-tip bracket to rear range foot.
Reconnect the anti-tip bracket, if the range is moved.
See the installation instructions for details.
Failure to follow these instructions can result in death or serious burns to children and adults.



Anti-Tip Bracket



Range Foot

Making sure the anti-tip bracket is installed:

- Slide range forward.
- Look for the anti-tip bracket securely attached to floor.
- Slide range back so rear range foot is under anti-tip bracket.

Range Safety

Your safety and the safety of others is very important.

We have provided many important safety messages in this manual and on your appliance. Always read and obey all safety messages.



This is the safety alert symbol.

This symbol alerts you to hazards that can kill or hurt you and others.

All safety messages will be preceded by the safety alert symbol and the word "DANGER" or "WARNING." These words mean:

! DANGER

You will be killed or seriously injured if you don't follow instructions.

! WARNING

You can be killed or seriously injured if you don't follow instructions.

All safety messages will identify the hazard, tell you how to reduce the chance of injury, and tell you what can happen if the instructions are not followed.

IMPORTANT SAFETY INSTRUCTIONS

WARNING: To reduce the risk of fire, electric shock, injury to persons, or damage when using the range, follow basic precautions, including the following:

- **WARNING** – TO REDUCE THE RISK OF TIPPING OF THE RANGE, THE RANGE MUST BE SECURED BY PROPERLY INSTALLED ANTI-TIP DEVICES. TO CHECK IF THE DEVICES ARE INSTALLED PROPERLY, SLIDE RANGE FORWARD, LOOK FOR ANTI-TIP BRACKET SECURELY ATTACHED TO FLOOR, AND SLIDE RANGE BACK SO REAR RANGE FOOT IS UNDER ANTI-TIP BRACKET.
- **CAUTION** – Do not store items of interest to children in cabinets above a range or on the backguard of a range – children climbing on the range to reach items could be seriously injured.
- Proper Installation – Be sure the range is properly installed and grounded by a qualified technician.
- Never Use the Range for Warming or Heating the Room.
- Do Not Leave Children Alone – Children should not be left alone or unattended in area where the range is in use. They should never be allowed to sit or stand on any part of the range.
- Wear Proper Apparel – Loose-fitting or hanging garments should never be worn while using the range.
- User Servicing – Do not repair or replace any part of the range unless specifically recommended in the manual. All other servicing should be referred to a qualified technician.
- Storage in or on the Range – Flammable materials should not be stored in an oven or near surface units.
- Do Not Use Water on Grease Fires – Smother fire or flame or use dry chemical or foam-type extinguisher.

– SAVE THESE INSTRUCTIONS –

IMPORTANT SAFETY INSTRUCTIONS

- Use Only Dry Potholders – Moist or damp potholders on hot surfaces may result in burns from steam. Do not let potholder touch hot heating elements. Do not use a towel or other bulky cloth.
- DO NOT TOUCH SURFACE UNITS OR AREAS NEAR UNITS – Surface units may be hot even though they are dark in color. Areas near surface units may become hot enough to cause burns. During and after use, do not touch, or let clothing or other flammable materials contact surface units or areas near units until they have had sufficient time to cool. Among those areas are the cook-top and surfaces facing the cook-top.
- Use Proper Pan Size – The range is equipped with one or more surface units of different size. Select utensils having flat bottoms large enough to cover the surface unit heating element. The use of undersized utensils will expose a portion of the heating element to direct contact and may result in ignition of clothing. Proper relationship of utensil to burner will also improve efficiency.
- Never Leave Surface Units Unattended at High Heat Settings – Boilover causes smoking and greasy spillovers that may ignite.
- Protective Liners – Do not use aluminum foil to line oven bottoms, except as suggested in the manual. Improper installation of these liners may result in a risk of electric shock, or fire.
- Glazed Cooking Utensils – Only certain types of glass, glass/ceramic, ceramic, earthenware, or other glazed utensils are suitable for range-top service without breaking due to the sudden change in temperature.
- Utensil Handles Should Be Turned Inward and Not Extend Over Adjacent Surface Units – To reduce the risk of burns, ignition of flammable materials, and spillage due to unintentional contact with the utensil, the handle of a utensil should be positioned so that it is turned inward, and does not extend over adjacent surface units.
- Do Not Cook on Broken Cook-Top – If cook-top should break, cleaning solutions and spillovers may penetrate the broken cook-top and create a risk of electric shock. Contact a qualified technician immediately.
- Clean Cook-Top With Caution – If a wet sponge or cloth is used to wipe spills on a hot cooking area, be careful to avoid steam burn. Some cleaners can produce noxious fumes if applied to a hot surface.
- Use Care When Opening Door – Let hot air or steam escape before removing or replacing food.
- Do Not Heat Unopened Food Containers – Build-up of pressure may cause container to burst and result in injury.
- Keep Oven Vent Ducts Unobstructed.
- Placement of Oven Racks – Always place oven racks in desired location while oven is cool. If rack must be moved while oven is hot, do not let potholder contact hot heating element in oven.

– SAVE THESE INSTRUCTIONS –

continued on next page



IMPORTANT SAFETY INSTRUCTIONS

- **DO NOT TOUCH HEATING ELEMENTS OR INTERIOR SURFACES OF OVEN** – Heating elements may be hot even though they are dark in color. Interior surfaces of an oven become hot enough to cause burns. During and after use, do not touch, or let clothing or other flammable materials contact heating elements or interior surfaces of oven until they have had sufficient time to cool. Other surfaces of the appliance may become hot enough to cause burns – among these surfaces are oven vent openings and surfaces near these openings, oven doors, and windows of oven doors.

For self-cleaning ranges –

- **Do Not Clean Door Gasket** – The door gasket is essential for a good seal. Care should be taken not to rub, damage, or move the gasket.
- **Do Not Use Oven Cleaners** – No commercial oven cleaner or oven liner protective coating of any kind should be used in or around any part of the oven.
- **Clean Only Parts Listed in Manual.**
- **Before Self-Cleaning the Oven** – Remove broiler pan and other utensils.

For units with ventilating hood –

- **Clean Ventilating Hoods Frequently** – Grease should not be allowed to accumulate on hood or filter.
- **When flaming foods under the hood, turn the fan off.** The fan, if operating, may spread the flame.

– SAVE THESE INSTRUCTIONS –

P

arts and Features

This section tells you what features your range has and where they are located. It also discusses some convenience features that you should know about, but which are not needed to operate the range. Please review this information before using your range. To help you find information on specific parts or features quickly, page references are included.

Feature locations (Slide-in models)

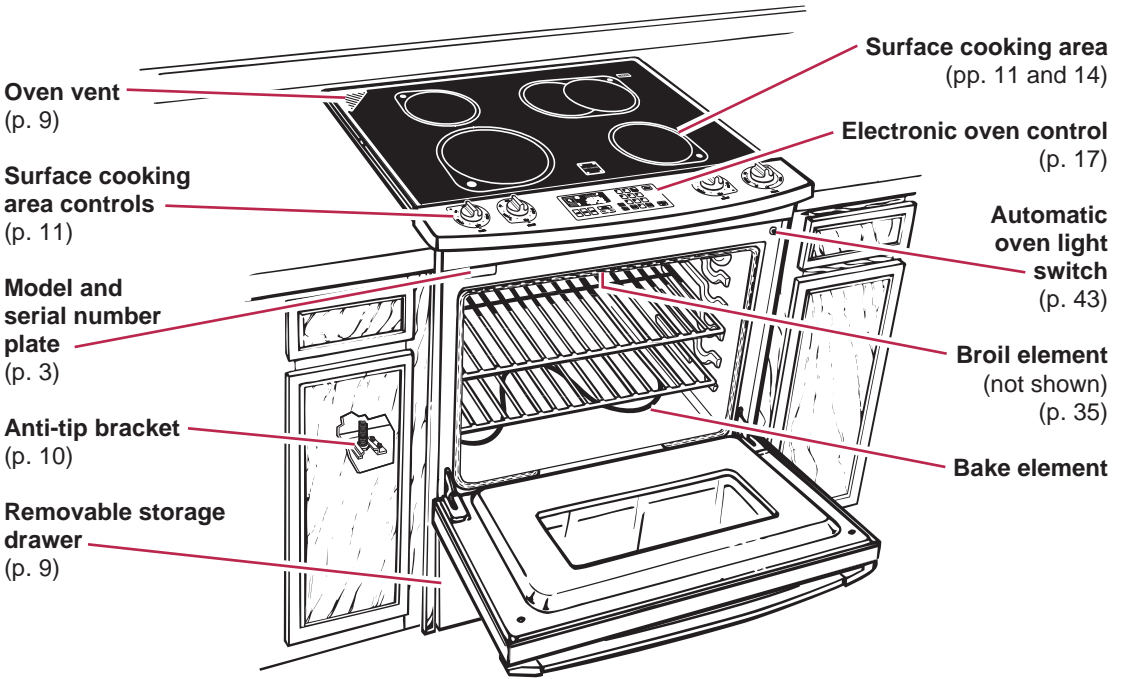

Surface cooking area controls

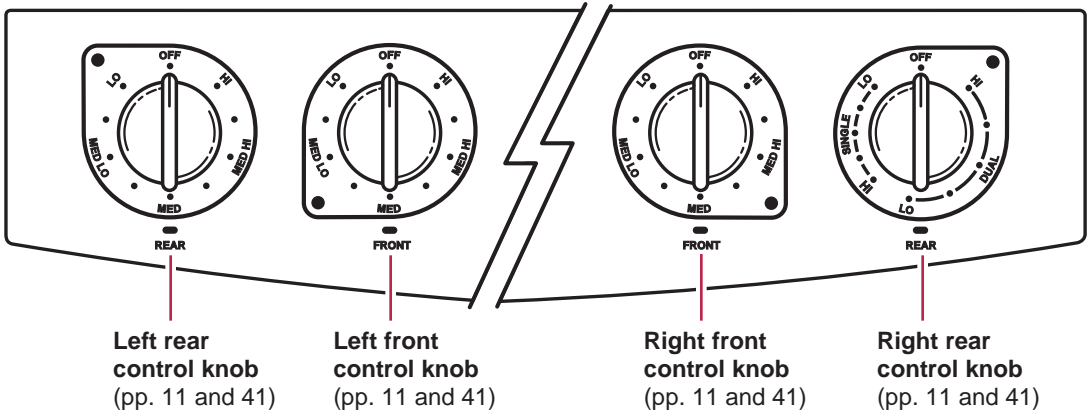



(Freestanding models)

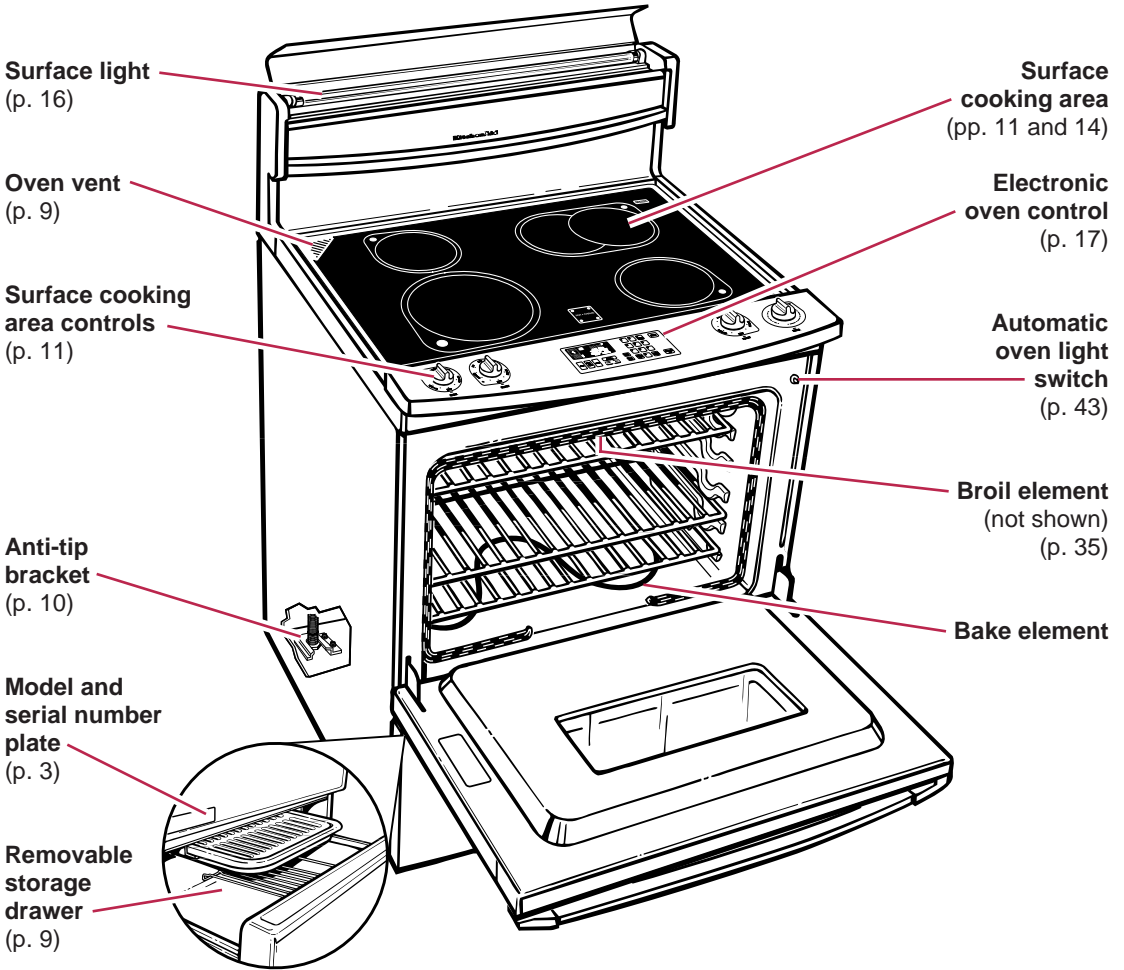

Surface cooking area controls

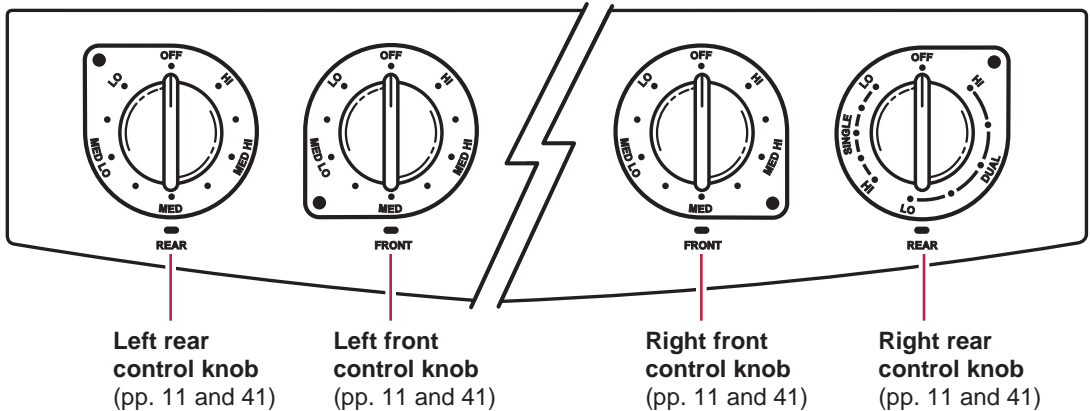



The oven vent

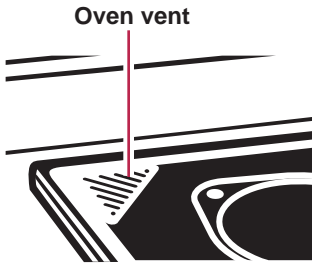

Hot air and moisture escape from the oven through a vent in the left rear corner of the cooktop. **Do not block the vent by using large pans or covers.** Poor baking/roasting can result.

NOTE: Plastic utensils left over the vent can melt.

! WARNING

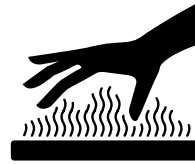

Burn Hazard

Use pot holders when touching items left near oven vent.

Failure to do so can result in burns.

The storage drawer

You can remove the storage drawer to make it easier to clean under the range. **Use care when handling the drawer.**

Removing the storage drawer:

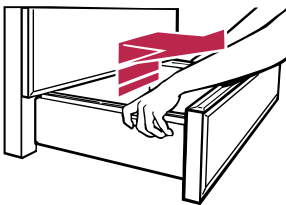

1. **Empty** drawer of any pots and pans before removing drawer. **Use** recessed area on top edge of drawer to pull drawer straight out to the first stop. **Lift** front and **pull out** to the second stop.
2. **Lift** back slightly and **slide** drawer all the way out.

Replacing the storage drawer:

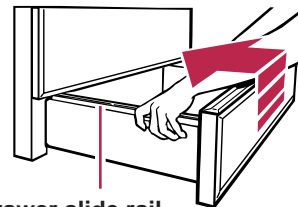

Drawer slide rail

1. **Fit** ends of drawer slide rails into the drawer guides on both sides of opening.
2. **Lift** drawer front and **press in** until metal stops on drawer slide rails clear white stops on drawer guides. **Lift** drawer front again to clear second stop and **slide** drawer closed.



The anti-tip bracket

The range will not tip during normal use. However, tipping can occur if you apply too much force or weight to the open door without the anti-tip bracket properly secured.

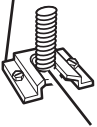
	<p style="text-align: center;">! WARNING</p> <p style="text-align: center;">Tip Over Hazard</p> <p>A child or adult can tip the range and be killed. Connect anti-tip bracket to rear range foot. Reconnect the anti-tip bracket, if the range is moved. See the installation instructions for details. Failure to follow these instructions can result in death or serious burns to children and adults.</p>
<p>Anti-Tip Bracket</p>  <p>Range Foot</p>	<p>Making sure the anti-tip bracket is installed:</p> <ul style="list-style-type: none">• Slide range forward.• Look for the anti-tip bracket securely attached to floor.• Slide range back so rear range foot is under anti-tip bracket.

Using and Caring for Your Cooktop

This section tells you how to operate the controls to the cooktop. It also discusses how the ceramic glass cooktop works, and includes tips on how to cook with and maintain the cooktop.

Using the surface cooking areas

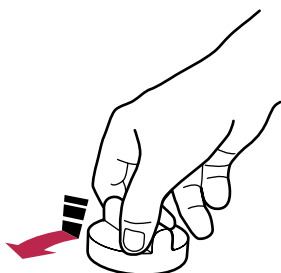

Control knobs

Push in control knobs before turning them to a setting. Set them anywhere between HI and OFF.

Surface cooking area markers

The solid dot in the surface cooking area marker shows which surface cooking area is turned on by that knob.

Power on lights

When you use a control knob to turn on a surface cooking area, the Power On Light by that knob will glow.

FRONT

Hot surface indicator lights

The Hot Surface Indicator Lights on the cooktop surface will glow when any of the surface cooking areas are hot. The Indicator Lights will continue to glow as long as the surface cooking areas are too hot to touch, even after they are turned off.

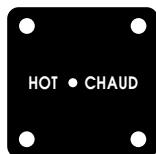

("CHAUD" is French for "HOT")

! WARNING



Fire Hazard

Turn off all controls when done cooking.

Failure to do so can result in death or fire.

Control setting guide

For best results, start cooking at the high setting; then turn the control knob down to continue cooking.

SETTING	RECOMMENDED USE
HI	<ul style="list-style-type: none"> To start foods cooking. To bring liquids to a boil.
MED HI	<ul style="list-style-type: none"> To hold a rapid boil. To fry chicken or pancakes.
MED	<ul style="list-style-type: none"> For gravy, pudding, and icing. To cook large amounts of vegetables.
MED LO	<ul style="list-style-type: none"> To keep food cooking after starting it on a higher setting.
LO	<ul style="list-style-type: none"> To keep food warm until ready to serve.



Using and Caring for Your Cooktop

Using the dual-size surface cooking area

(some models)

You can use the right rear surface cooking area as either a small diameter, lower wattage element or large diameter, full wattage element.

Use both elements for larger pans

Use small element for smaller pans



To use the small element (for smaller pans):

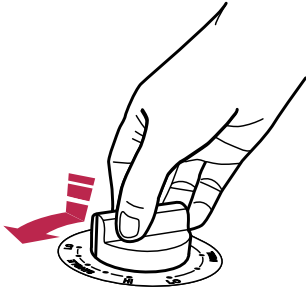

- **Push in and turn** the control knob to the left (counterclockwise) to the desired setting in the area marked "SINGLE."

To use both elements (for larger pans):

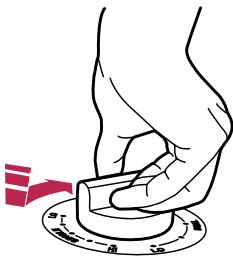

- **Push in and turn** the control knob to the right (clockwise) to the desired setting in the area marked "DUAL."

NOTE: You can turn the control knob in either direction to reach "OFF."

The ceramic glass cooktop

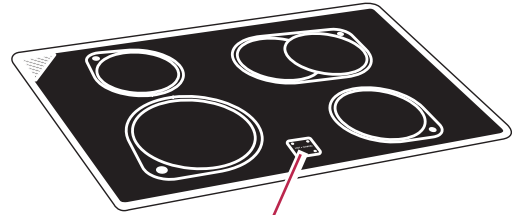

Hot surface indicator lights

Cooking on the ceramic glass cooktop is almost the same as cooking on coil elements. There are, however, a few differences:

- **The surface cooking area** will glow red when the element is turned on. You will see the element cycling on and off – even on the HI setting – to help the area stay at the temperature setting you choose.
- **Wiping off** the cooktop before and after each use will help keep the surface free from stains and give you the most even heating. See "Cleaning the cooktop" in the "Caring for Your Range" section.
- **Do not cook** foods directly on the cooktop.
- **Lift pots and pans** onto and off of the cooktop. Sliding pots and pans on the cooktop could leave marks that are difficult to remove or could leave permanent marks.
- **Do not cook** popcorn that comes in prepackaged aluminum containers on the cooktop. The container could leave aluminum marks on the cooktop that cannot be removed completely.
- **Do not use** the cooktop as a cutting board.
- **Do not allow** anything that could melt, such as plastic or aluminum foil, to come in contact with the cooktop while it is hot.
- **Dropping** a heavy or hard object on the cooktop could crack it. Be careful when using heavy skillets and large pots. Do not store jars or cans above the cooktop.
- **Sugary spills** and soils can cause pitting. See "Cleaning the cooktop" in the "Caring for Your Range" section.



Cookware tips

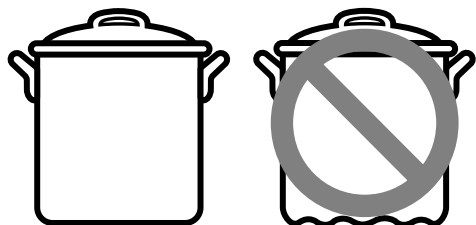

- **Use the correct cookware** to prevent damage to the surface cooking area, cooktop, wiring, and surrounding areas.
- **If the cookware is too small** for the surface cooking area or the bottom is not flat, the surface cooking area could stay glowing red for an extended length of time causing damage to the range.
- **If you start cooking on high**, it is important to turn the control down to a lower setting to complete cooking.
- **Flat-bottomed cookware**, including woks, canners, and teakettles, will provide better contact with the surface cooking area and provide the best cooking results.
- **Warped, dented, and ribbed-bottomed cookware** can result in uneven cooking due to incomplete contact with the surface cooking area.
- **Cookware** that has been designed with slightly indented bottoms or small expansion channels can be used.
- **Choose medium to heavy gauge** (thickness) cookware.
- **The pan material** (type of metal or glass) affects how quickly and evenly the pan heats.
- **Check for rough spots** on the bottom of your metal or glass cookware which could scratch the ceramic glass surface.
- **Make sure the bottoms** of pots and pans are clean and dry before using them. Food and water particles left on the bottoms can leave deposits on the cooktop when it is heated.

NOTE: Do not leave empty cookware, or cookware which has boiled dry, on a hot surface cooking area. The cookware could overheat, causing damage to the cookware or surface cooking area.

Home canning information

- **Use flat-bottomed canner/pan.** Canners with rippled or ridged bottoms do not allow good contact with the surface cooking area.



- **Use the largest surface cooking area** and center the canner/pan on it. A large diameter canner/pan, if not centered correctly, can trap heat and cause damage to the cooktop.
- **Do not place your canner/pan** on 2 surface cooking areas at the same time. Too much heat will build up and damage the cooktop.
- **Start with hot water.** This reduces the time the control is set on high. Reduce the heat setting to the lowest position needed to keep water boiling.
- **When canning for long periods of time**, alternate use of the surface cooking areas between batches to allow the areas to cool down, or prepare food in small batches.
- **Refer** to your canner manual for specific instructions.



Energy saving tips

Although the energy used for cooking is usually a very small percentage of the total energy used in the home, cooking energy can be used efficiently. Here are some tips to help you save energy when using your cooking product:

Cooktop

- **Match the pan** to the surface cooking area size.
- **The pan** should have a flat bottom, straight sides, and a well-fitting lid.
- **To help shorten your cooking time**, use the least amount of liquid possible.
- **Preheat your pots and pans** only when recommended and for the shortest time possible.

- **Start your food** on a higher heat setting, then turn the control to a lower setting to finish cooking.
- **Place a filled pan** on the surface cooking area before turning it on.

Oven

- **“Oven peeking”** can make cooking times longer and affect the food quality.
- **Rely on a timer** to keep track of cooking time.
- **Plan** your meals for the most efficient use of the oven by cooking more than one food at a time, or baking while the oven is still hot after cooking a meal.
- **It is not necessary to preheat** the oven when broiling or roasting, unless your recipe recommends doing so.

Caring for your cooktop

Your cooktop is designed for easy care. However, you need to maintain your ceramic glass cooktop differently than you would standard electric open-coil elements. Foods spilled directly on the cooktop will not burn off as on open-coil elements. Because of this, you should keep the surface dust free and soil free before heating.

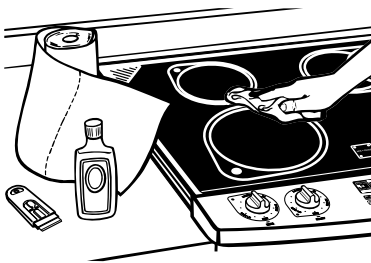

Your cooktop has been prepolished at the factory for improved protection and easier cleaning. The Cooktop Polishing Creme included with your range, paper towels or a sponge, and a single-edge razor blade in the holder are all you need to clean your cooktop. For proper cleaning methods, please review “Cleaning tips” later in this section.

Follow them each time you use your cooktop. This will ensure you get the best performance out of your cooktop, as well as preserve that uniquely elegant look.

NOTE: Let cooktop cool before cleaning.

To avoid damaging the cooktop, follow these instructions:

- **Remove** sugar spills and soils from the cooktop while the surface is still warm to avoid pitting on the surface.
- **Marks from sliding** metal pans on the cooktop are difficult to remove completely. Use cooktop polishing creme to clean the area. Several applications may be necessary.
- **Do not use** steel wool, plastic cleaning pads, gritty powdered cleansers, chlorine bleach, rust remover, ammonia, or glass cleaning products with ammonia. These could damage the cooktop surface.



Cleaning tips

What to use:

- **Cooktop Polishing Creme (included with your range) with paper towel or clean, damp sponge** – This creme has been developed especially for cleaning and protecting your cooktop. When using the creme, follow the instructions on the container.

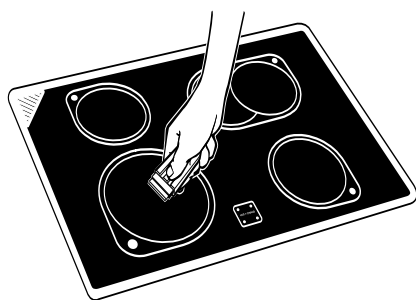

- **Razor scraper in a holder (not included with your range)** – Use to remove cooked-on soils from your ceramic glass cooktop. To avoid scratches, keep the razor blade as flat against the cooktop as possible. **Store razor blades out of reach of children.**

Steps to follow:

1. **Most spills** can be wiped off easily using a paper towel or clean, damp sponge as soon as the Hot Surface Indicator Light goes off.
2. **For stubborn spills**, rub Cooktop Polishing Creme into cooked-on soil using a paper towel. If some soil remains, leave some creme on the spot(s) and follow Step 3.
3. **Carefully scrape** spots with the razor scraper.
4. **Finish** by polishing entire cooktop with Cooktop Polishing Creme and a paper towel.

To order Cooktop Polishing Creme (Part No. 3184477), call 1-800-422-1230. You will hear a recording. Follow the steps to place an order.

How to keep your cooktop looking like new:

IF THERE ARE	WHAT TO DO
Sugary spills and soils (such as jellies and candy syrups)	To prevent pitting on the cooktop, wipe up with a paper towel or clean, damp sponge while the ceramic glass surface is still warm. Remove spills as soon as possible after they occur.
Dark streaks, specks, and discoloration	Use the Cooktop Polishing Creme or a nonabrasive cleanser with a damp paper towel or sponge.
Metal marks (from copper and aluminum pans)	Use the Cooktop Polishing Creme with a damp paper towel or sponge before heating the cooktop again. If heated before cleaning, metal marks may not come off.
Tiny scratches or abrasions	Scratches and abrasions do not affect cooking. After many cleanings, they will become less visible. To prevent scratches and abrasions, use the Cooktop Polishing Creme regularly.

NOTE: Always wipe your cooktop with clean water and dry it well after using the cleanser to prevent streaking or staining.



Using and replacing the surface light (Freestanding models)

The surface light is in the backguard. It is controlled by the Surface Light Command Pad on the control panel.

To turn the surface light on or off:
PRESS



Replacing the surface light:

1. Unplug range or disconnect power.

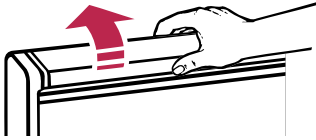

2. Flip up the top of the backguard.

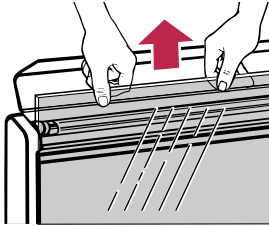

3. Pull up glass on front of backguard.

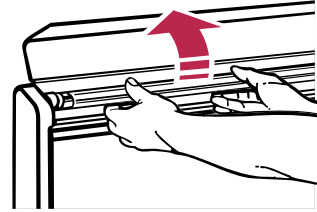

4. Grasp the fluorescent light tube at both ends. Turn the tube approximately 90° in either direction until both ends come out of the receptacles. Replace with a 20-watt cool-white fluorescent light tube.

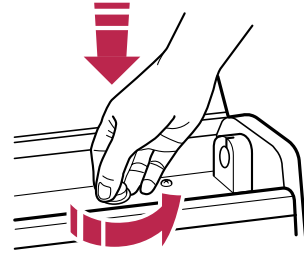

5. If the surface light still does not work, you may need to replace the starter. The starter is a knob-shaped part located on the right side of the backguard, under the light tube. To remove and replace the starter, first remove light tube. Push starter in and turn approximately 90° counterclockwise. Pull starter out of recessed area. You can find replacement starters at stores that sell fluorescent light tubes.
6. Replace glass and close the top panel.
7. Plug in range or reconnect power.

Using and Caring for Your Oven

This section tells you, step by step, how to operate all oven functions controlled by the electronic control. Carefully follow these instructions, along with the cooking tips and cleaning information, for successful use of your range. Your model may not have all the features as shown on the electronic oven control below.

Using the electronic oven control

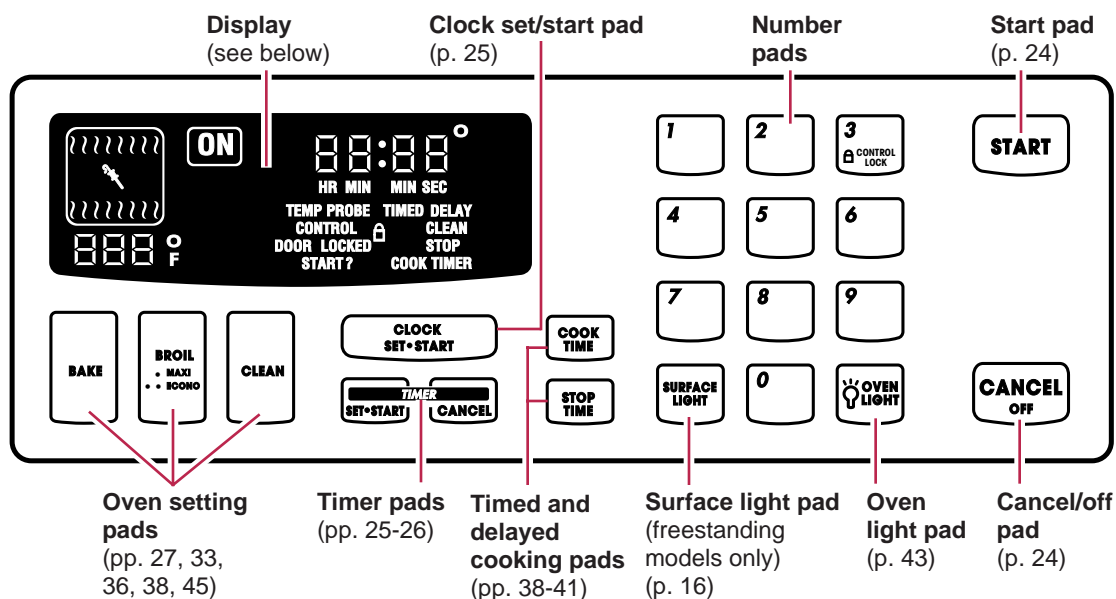

Display/clock

- **When you first plug in the range**, a tone will sound, the display will be fully lit for a few seconds, and the display will show the last time set and "PF" (power failure). If, after you set the clock (see "Setting the clock" later in this section), the display again shows "PF," your electricity was off for a while. Reset the clock.
- **The time display will show "Err"** and 3 short tones will sound if a time or temperature is incorrectly entered.

NOTE: If you press a command pad several times, the pad can stop working. If you wait a few seconds, you can use the pad again. When you first use the pad again, you may have to hold down on the pad a short time to get it to work.



Using and Caring for Your Oven

Fahrenheit/Celsius

To set your oven to cook in Celsius instead of Fahrenheit:

1. Open the door.

2. Press CANCEL/OFF.

PRESS



3. Press the Number Pads 1, 2, and 3, in that order.

PRESS

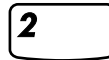

4. Press BROIL.

PRESS



5. Start oven.

NOTES:

- Press **BAKE** to confirm that you are using Celsius.
- **Only the temperature** and a flashing degree symbol will appear in the temperature display area when you set your oven to cook in Celsius.

PRESS



Repeat the steps above to change from Celsius to Fahrenheit.



If you need to convert temperatures from Celsius to Fahrenheit or vice versa, you can refer to this chart:

Temperature replacement values

38°C=100°F	163°C=325°F
60°C=140°F	177°C=350°F
66°C=150°F	191°C=375°F
77°C=170°F	204°C=400°F
93°C=200°F	218°C=425°F
121°C=250°F	232°C=450°F
135°C=275°F	246°C=475°F
149°C=300°F	260°C=500°F

Disable/enable audible signals

Audible signals tell you if a function is entered correctly or not. They also tell you when a cycle is completed. To turn off key entry tone, end-of-cycle tone, and reminder tones, follow these steps:

1. Open the door.

2. Press CANCEL/OFF.

PRESS



continued on next page



Using and Caring for Your Oven

3. Press the Number Pads 1, 2, and 3, in that order.

PRESS

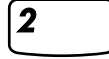

4. Press TIMER SET/START.

PRESS



5. Start oven.

“Snd” and “Off” will appear on the display.

PRESS



Repeat Steps 1-5 to turn the signals back on.

“Snd” and “On” will appear on the display.



Using the control lock

The control lock prevents unwanted use of the oven by disabling the control panel command pads.

NOTES:

- **Control lock** is only available when oven is not active or set.
- **Control lock** will not disable the Timer.
- **Set control lock** when cleaning the control panel to prevent oven from accidentally turning on.

To lock or deactivate the control panel:

1. Open the door.

2. Press and hold CONTROL LOCK (Number Pad 3) for 5 seconds.

A single tone will sound and “START?” will appear on the display.

PRESS



YOU SEE



3. Press START.

PRESS



YOU SEE



To unlock the control panel:

1. Open the door.

2. Press and hold CONTROL LOCK (Number Pad 3) for 5 seconds.

A single tone will sound and “CONTROL LOCK ” will disappear from the display.

PRESS





Using and Caring for Your Oven

Using the Sabbath mode

What your oven will do while in the Sabbath mode:

- **The time display** will show “SAb” to tell you that the oven is in the Sabbath mode.
- **The ON Indicator Light** will light up when the burner turns on and ON will go off when the burner turns off.
- **To prevent accidental key presses**, the key pads will only work after you press them for 1 second.
- **No tones** will sound.

To enable the Sabbath mode:

1. Open the door.

2. Press CANCEL/OFF.

PRESS



3. Press the Number Pads 7, 8, and 9, in that order.

PRESS

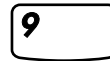

4. Press Number Pad 6.

PRESS

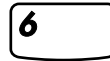

5. Press START.

“SAb” and “On” will appear on the display.

PRESS



To disable the Sabbath mode:

Repeat the steps above to disable the Sabbath mode. “SAb” and “Off” will appear on the display.



Setting your range for the Sabbath†

If you want to set your range to meet “no work” requirements for the Sabbath, first turn on the Sabbath mode (see “To enable the Sabbath mode” earlier in this section). Then follow these steps:

1. Turn the oven light and/or surface light (if available) on or off.

NOTE: See “Using and replacing the surface light” in the “Using and Caring for Your Cooktop” section and “Using and replacing the oven light(s)” in the “Using and Caring for Your Oven” section for more information.

These lights will stay turned on or off (whichever you set) while in the Sabbath mode. Opening the door will not turn on the oven light if it is programmed to be off.

2. Open the door.

3. Press BAKE.

PRESS



4. Press Number Pads to set the temperature you want.

Example for 325°F (163°C):

PRESS

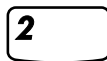

5. Start oven.

PRESS



† Star K certification pending. Full certification by Star K is expected by the end of 1997. Information is accurate as of 9/97.



Using and Caring for Your Oven

6. Press and hold Number Pad 6 for 5 seconds.

“START?” appears on the display.

PRESS

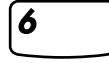

YOU SEE



7. Press START.

“SAb” appears on the display.

PRESS



YOU SEE



To end the Sabbath mode and turn off the oven:

1. Open the door.

2. Press and hold Number Pad 6 for 5 seconds.

PRESS

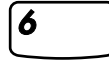

Starting an operation

After programming a function, you must press START to start the function. If you do not press START within 5 seconds of programming, “START?” will show on the display as a reminder.



Canceling an operation

CANCEL/OFF will cancel any function, except for the CLOCK SET/START and Timer functions. When you press CANCEL/OFF, the large display will show the time of day or, if the Timer is also being used, the time remaining.



Setting the clock

NOTE: If an oven function is active or programmed, you cannot change the clock.

1. Press CLOCK SET/START.

PRESS



YOU SEE



2. Set time.

PRESS



YOU SEE

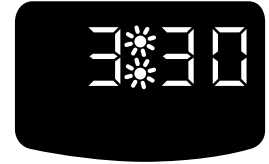

3. Start clock.

If time has not been entered correctly, 3 short tones will sound and “Err” will be displayed. The display will show the closest valid time. Repeat Steps 2 and 3 to re-enter the time of day.

NOTE: You can clear the time of day from the display by opening the door, then pressing and holding CLOCK SET/START for 5 seconds. Repeat to see time of day on display again.

PRESS



YOU SEE



Using the timer

The Timer does not start or stop the oven. It works like a regular kitchen timer. It can be set in hours and minutes up to 99 hours, 59 minutes or in minutes and seconds up to 99 minutes, 59 seconds.

1. Press TIMER SET/START.

- **Once** to set hours and minutes
- **Twice** to set minutes and seconds

PRESS



YOU SEE



(example shows hours and minutes)



Using and Caring for Your Oven

2. Set time.

PRESS

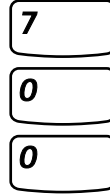

YOU SEE



(example shows a 7-hour timer setting)

3. Start Timer.

The Timer will begin counting down immediately after you press TIMER SET/START or START.

PRESS



YOU SEE

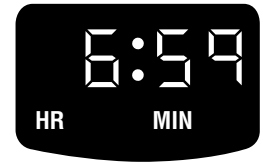

4. When time is up, turn off Timer.

When time is up, you will hear four tones (unless the audible signals have been disabled). Press TIMER CANCEL to clear the display.

YOU SEE



To change the timer during its operation:

1. Press **TIMER SET/START**.
2. Enter new desired time.
3. Press **TIMER SET/START**.

To cancel the timer during its operation:

You can cancel the Timer any time during its operation. Press **TIMER CANCEL**.

PRESS





Baking or roasting

1. Position racks.

For correct rack placement, see “Rack positions” and the “Rack placement” chart later in this section.

NOTES:

- **Before turning oven on** position oven rack(s) in desired location.
- **Be sure** the rack(s) is level.
- **Use pot holders or oven mitts to protect hands** if rack(s) must be moved while oven is hot.
- **Do not let** pot holder or oven mitt touch hot elements.
- **See “Cooking tips”** later in this section for additional baking and roasting tips.

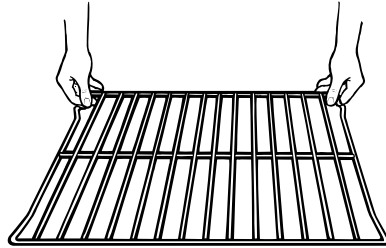

2. Choose baking/roasting setting.

PRESS



YOU SEE



(or 177°C)

3. Set temperature (optional).

Do this step if you want to set a temperature other than 350°F (177°C).

NOTE: See a reliable cookbook for temperature recommendations.

PRESS

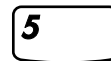

YOU SEE



(example for Bake at 375°F [191°C])

4. When baking, preheat oven.

After the temperature reaches 170°F (77°C), the temperature display will show the actual oven temperature at each 5°F (3°C) increase and stop at the set temperature. One long tone will sound when oven is preheated.

NOTE: When roasting, preheating is not needed unless your recipe recommends it.

PRESS



YOU SEE



(“Lo” is displayed after 5 seconds if oven temperature is below 170°F [77°C])

continued on next page



Using and Caring for Your Oven

5. Put food in oven.

NOTE: If you want to change the baking temperature after baking has begun, repeat Steps 2, 3, and 4.

6. After cooking, turn off oven.

PRESS



YOU SEE

(display will go blank)

Cooking tips

Baking tips

The hot air must circulate around the pans in the oven for even heat to reach all parts of the oven. This results in better baking.

For best air circulation:

- **Place** the pans so that one is not directly over the other.



- **For best results**, allow 1½ to 2 inches (3.7 to 5 cm) of space around each pan and between pans and oven walls.
- **When baking with 1 pan**, place pan in the center of the oven rack.

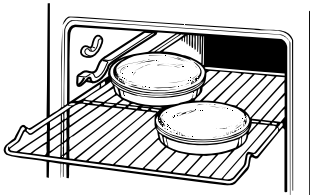

- **When baking with 2 pans**, place pans in opposite corners of the oven rack.

NOTES:

- **“Oven peeking”** may cause heat loss, longer cooking times, and unsatisfactory baking or roasting results. Rely on your timer.
- **Do not allow pans** to touch the heat sensor on the left wall near the back. Poor baking may result.

Rack positions

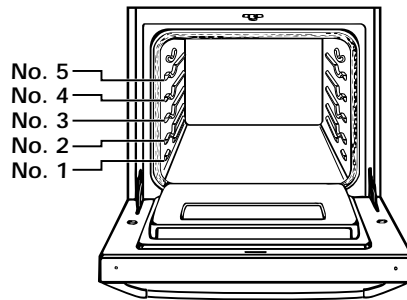

Your oven has two straight racks and five rack positions. Rack position 5 is the highest position, or farthest from the bottom of the oven. Rack position 1 is the lowest position, or closest to the bottom of the oven.



For proper cooking, follow these guidelines:

- **When using 1 rack**, place the rack so the top of the food will be centered in the oven.
- **When using 2 racks**, place one rack in position 1 and the other rack in position 3.
- **Use only 1** cookie sheet in the oven at a time when using the Bake setting.

Bakeware tips

- **When baking with insulated cookie sheets or baking pans**, place them in the bottom third of the oven. You may need to increase the recommended baking times, so test for doneness before removing from the oven.
- **When using ovenproof glassware or dark bakeware**, reduce the oven temperature by 25°F (16°C), but use the same baking time. Because these pans absorb heat, producing darker bottom browning and crispier crusts, place the rack in the center of the oven. When baking pies and bread, you can use the temperature suggested in the recipe.

Rack placement for specific foods:

(For rack positions, see “Rack positions” earlier in this section.)

FOOD	RACK POSITION
Frozen pies	2
Angel food and bundt cakes, most quick breads, yeast breads, casseroles, meats	1 or 2
Cookies, biscuits, muffins, cakes, nonfrozen pies	2 or 3

NOTE: For additional baking tips, see “Baking or roasting” earlier in this section.

Using aluminum foil in the oven

Use aluminum foil to catch spillovers from pies or casseroles.

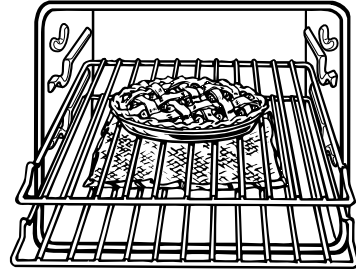

- **Place** the foil on the oven rack below the rack with the food. Turn foil edges up and make sure foil is about 1 inch (2.5 cm) larger all around than the dish holding the food.
- **Do not cover** the entire rack with aluminum foil. It will reduce air circulation and cause poor cooking results.
- **Do not line** oven bottom or entire oven rack with foil or other liners. It could affect the quality of your baking.



Baking chart

FOOD	OVEN TEMPERATURE	APPROXIMATE COOKING TIME (MINUTES)
Breads, yeast		
• loaf	375°F (191°C)	30-40
• rolls, pan	400°F (204°C)	12-15
Breads, quick		
• biscuits	450°F (232°C)	10-15
• muffins	400°F (204°C)	20-25
• popovers	450°F (232°C)	20-25
• corn bread	425°F (218°C)	25-30
• nut bread	350°F (177°C)	60-75
• gingerbread	350°F (177°C)	25-30
Cakes		
• angel food	375°F (191°C)	30-40
• layer cake	350-375°F (177-191°C)	20-30
• loaf cake	350°F (177°C)	35-45
• sponge cake	350°F (177°C)	35-45
• pound cake	350°F (177°C)	34-45
• fruit cake	300°F (149°C)	2-2½ hrs
• sheet cake	300°F (149°C)	25-35
Cookies		
• drop	375°F (191°C)	10-15
• rolled and refrigerated	375°F (191°C)	12-18
• chocolate	375°F (191°C)	10-15
• fruit and molasses	375°F (191°C)	10-15
• brownies	350°F (177°C)	20-30
• macaroons	350°F (177°C)	12-15
Miscellaneous		
• apples, baked	375°F (191°C)	50-60
• beans, baked	300°F (149°C)	5-6 hrs
• custard, cup	325°F (163°C)	35-40
• potatoes, baked	400°F (204°C)	75
• pudding		
bread	350°F (177°C)	45-60
cottage	375°F (191°C)	30-40
rice	325°F (163°C)	40-60
• scalloped dishes	350°F (177°C)	60-90
• soufflé	350°F (177°C)	50-60
Pastries		
• cream puffs	400°F (204°C)	35-40
• custard and pumpkin pie	350°F (177°C)	30-40
• pastry shell	450°F (232°C)	10-12
• two crust fruit pie		
cooked filling	400°F (204°C)	25-30
uncooked filling	400°F (204°C)	40-50
• meringue topping	350°F (177°C)	10-15

Temperatures and times are guidelines only and may need to be adjusted to individual tastes.



Roasting tips

- **Roast** meats fat-side up in a shallow pan using a roasting rack.
- **Use a roasting pan** that fits the size of the food to be roasted. Meat juices may overflow the sides of a pan that is too small. Too large of a pan will result in increased oven spatter.
- **Spatter can be reduced** by lining the bottom of the roasting pan with lightly crushed aluminum foil.

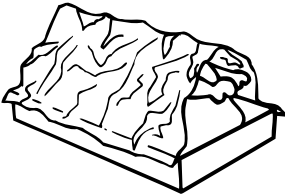

- **A foil tent** will slow down surface browning for long-term roasting, as when roasting a turkey. Place tent-shaped foil loosely over meat to allow for air circulation. Do not seal foil or meat will be steamed.

- **Use an accurate meat thermometer** to determine when meat has reached desired degree of doneness. Insert the thermometer into the center of the thickest portion of the meat or inner thigh or breast of poultry. For an accurate reading, the tip of the thermometer should not touch fat, bone, or gristle.
- **After reading the thermometer once**, push it further into the meat $\frac{1}{2}$ inch (1.2 cm) or more and read again. If the temperature drops, return the meat to the oven for more cooking.
- **Check pork and poultry** with a thermometer in two to three places to ensure adequate doneness.
- **Poultry and roasts will be easier to carve** if loosely covered with foil and allowed to stand 10-15 minutes after removal from the oven.

NOTE: See “Baking or roasting” earlier in this section for additional roasting tips.



Using and Caring for Your Oven

Roasting chart

- **Roast** at oven temperature of 325°F[†] (163°C). Preheating is not needed unless your recipe recommends it.
- **Place** roasting pan on rack position 1 or 2.

MEAT	APPROXIMATE WEIGHT	APPROXIMATE MINUTES PER POUND	MEAT THERMOMETER TEMPERATURE
Beef			
rolled rib	3-5 lbs (1.5-2 kg)		
• rare		25-29	140°F (60°C)
• medium		35-37	160°F (71°C)
• well-done		45-47	170°F (77°C)
standing rib	6-7 lbs (3 kg)		
• rare		23-25	140°F (60°C)
• medium		30-32	160°F (71°C)
• well-done		35-40	170°F (77°C)
rump roast	4-6 lbs (2-3 kg)		
• medium		25-30	160°F (71°C)
• well-done		35-37	170°F (77°C)
Lamb			
leg	6-7 lbs (3 kg)		
• rare		18-20	140°F (60°C)
• medium		21-24	150-155°F (66-69°C)
• well-done		30-32	180°F (82°C)
Pork			
loin	3-4 lbs (1.5-2 kg)	45-48	170°F (77°C)
	5-6 lbs (2-3 kg)	28-30	170°F (77°C)
shoulder	4-5 lbs (2 kg)	40-44	185°F (85°C)
ham, fully cooked	3-5 lbs (1.5-2 kg)	17-18	130°F (54°C)
	8-10 lbs (3.5-4.5 kg)	13-14	130°F (54°C)
Poultry			
chicken[†]	3-4 lbs (1.5-2 kg)	28-30	185°F ^{††} (85°C)
turkey, unstuffed	10-16 lbs (5-7 kg)	14-19	180-185°F (82-85°C)
	18-25 lbs (8-11 kg)	11-15	180-185°F (82-85°C)
Veal			
loin	3-4 lbs (1.5-2 kg)	35-38	170°F (77°C)
shoulder	5-6 lbs (2-3 kg)	43-45	170°F (77°C)

[†] For chicken, set the oven temperature to 350°F (177°C).

^{††} The muscles may not be large enough to use a thermometer.



Adjusting the oven temperature

Although your new oven is properly adjusted to provide accurate temperatures, it may cook faster or slower than your old oven.

If, after using the oven for a period of time, you are not satisfied with the baking/roasting results, you can change the offset temperature by following the steps below. The control will “remember” the selected offset even after the power has been interrupted or lost. To change the offset temperature:

NOTE: DO NOT measure oven temperature with a thermometer. Opening the oven door will lower the oven temperature and give you an inaccurate reading. Also, the thermometer temperature reading will change as your oven cycles.

1. Open the door.

2. Press CANCEL/OFF.

PRESS



3. Press the Number Pads 1, 2, and 3, in that order.

PRESS



4. Press BAKE.

PRESS



5. Start oven.

The display shows 0°F (-18°C) and “COOK TEMP.”

PRESS



YOU SEE



(or -18°C)

continued on next page



Using and Caring for Your Oven

6. Set the new offset temperature.

Press BAKE to increase the setting.
Press BROIL to decrease the setting.

PRESS



YOU SEE

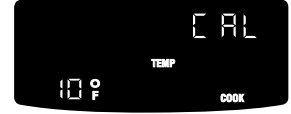

(example when making oven 10°F [or 6°C] hotter)

7. Press START to enter the adjustment.

NOTE: The offset temperature will remain the same if you press CANCEL/OFF.

PRESS



How to determine the amount of adjustment needed

The following chart tells you how much to adjust the offset temperature to get the desired cooking results. You can determine cooking results by amount of browning, moistness, and rising times for baked foods.

TO COOK FOOD ...	ADJUST BY THIS NUMBER OF DEGREES
A little more	+ 5°F to +10°F (+3°C to +6°C)
Moderately more	+15°F to +20°F (+8°C to +12°C)
Much more	+25°F to +35°F (+16°C to +21°C)
A little less	-5°C to -10°C (-3°C to -6°C)
Moderately less	-15°F to -20°F (-8°C to -12°C)
Much less	-25°F to -35°F (-16°C to -21°C)



Broiling

NOTE: Preheating is not necessary when broiling, unless your recipe recommends it.

1. Position rack.

See the “Broiling chart” later in this section for recommended rack positions.

NOTES:

- **Before turning oven on**, position oven rack(s) in desired location.
- **Be sure** the rack(s) is level.
- **Use pot holders or oven mitts to protect hands** if rack(s) must be moved while oven is hot.
- **Do not let** pot holder or oven mitt touch hot broil element.
- **See “Broiling tips”** later in this section for additional broiling tips.

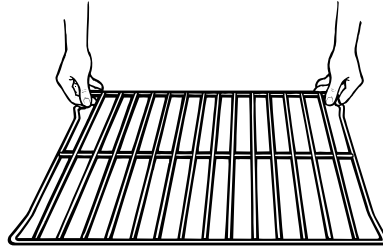

2. Put food in oven.

Place food on grid in broiler pan and place in center of the oven rack.

NOTES:

- **Place food** about 3 inches (7.5 cm) or more from the broil element.
- **To ensure adequate grease drainage**, do not use cookie sheets or similar pans for broiling.
- **If foil is used** to cover broiler grid, cut slits in foil to allow grease to drain away.



Broiler grid



Broiler pan

3. Position door.

Close the door to the Broil Stop position (open about 6 inches [15 cm]). The door will stay open by itself. Door must be partly open for the oven to maintain proper temperatures.

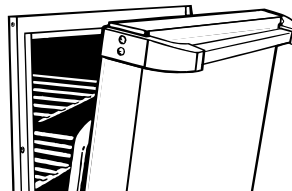

continued on next page



Using and Caring for Your Oven

4. Press BROIL.

Once for Maxi Broil

OR

Twice for Econo Broil

PRESS



YOU SEE



(example shows 500°F [260°C] for Maxi Broil)

PRESS



YOU SEE



(example shows 500°F [260°C] for Econo Broil)

5. Set temperature (optional).

Do this step if you want to use variable temperature broiling (see below).

NOTE: See “Broiling chart” later in this section for temperature recommendations.

PRESS

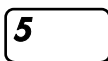
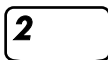

YOU SEE



(example shows 325°F [163°C] broiling temperature for Maxi Broil)

6. Start oven.

NOTE: If you want to change the broiling temperature after broiling has begun, repeat Steps 4, 5, and 6.

PRESS



YOU SEE



(example for Maxi Broil)

7. When broiling is done, turn off oven.

PRESS



YOU SEE

(display will go blank)

Variable temperature broiling

- **If food is cooking too fast** or you want the food to broil slower from the start, set the broil temperature between 170°F (77°C) and 325°F (163°C). These temperature settings allow the broil heating element to cycle and to slow cooking. The lower the temperature, the slower the cooking.
- **Fish and chicken** are some foods that may cook better if you use lower broiling temperatures.



Broiling tips

- **Always start** broiling with a cold broiler pan for even results.
- **To retain more natural juice**, do not pierce meat with a fork.
- **Trim** the outer layer of fat from steaks and chops.
- **Slit** fatty edges to prevent meat from curling during broiling.
- **Use a nonstick cooking spray or vegetable oil** on the broiler pan and grid when broiling fish to prevent sticking.
- **See “Broiling”** earlier in this section for additional broiling tips.

Broiling chart

The recommended rack position is numbered lowest (1) to highest (5).

MEAT	RACK POSITION	TEMPERATURE	APPROXIMATE TIME (MINUTES)	
			SIDE 1	SIDE 2
Steak, 1" (2.5 cm) thick	4	500°F (260°C)		
• rare			4	4
• medium			6	6
• well-done			8	8
Steak, 1½" (3.7 cm) thick	4	500°F (260°C)		
• rare			8	8
• medium			10	10
Hamburger patties or steaks, ½" (1.2 cm) thick or less	4	500°F (260°C)		
• medium			6	4
Lamb chops, 1" (2.5 cm) thick	4	400°F (204°C)	9	9
Ham slice, ½" (1.2 cm) thick	4	500°F (260°C)	5	5
precooked 1" (2.5 cm) thick	4	500°F (260°C)	10	10
Pork chops, 1" (2.5 cm) thick	4	450°F (232°C)	12	12
Frankfurters	4	500°F (260°C)	4	4
Chicken pieces	3	500°F (260°C)	16	16
Fish, 1" (2.5 cm) thick	3	350°F (177°C)	10	10
Beef liver, ½" (1.2 cm) thick	4	350°F (177°C)	5	5

Temperatures and times are guidelines only and may need to be adjusted to individual tastes.



Timed cooking

The electronic clock/oven control will turn the oven on and off at times you set, even when you are not around.

Delayed time cooking is ideal for foods which do not require a preheated oven, such as meats and casseroles. **Do not use delayed time cooking for cakes, cookies, etc. – they will not rise properly. Before using timed cooking, make sure the clock is set to the correct time of day.** (See the “Setting the clock” section.)

To start baking/roasting now and stop automatically:

1. Prepare oven.

Position the oven rack(s) properly and place the food in the oven. For correct rack placement, see “Rack positions” and the “Rack placement” chart earlier in this section.

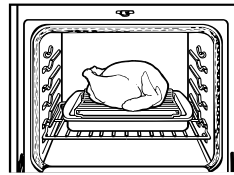

⚠ WARNING

Food Poisoning Hazard

Do not let food sit in oven more than one hour before or after cooking.

Doing so can result in death, food poisoning, or sickness.

2. Choose Bake setting.

PRESS



YOU SEE



(or 177°C)

3. Set temperature (optional).

Do this step if you want to set a temperature other than the one displayed.

NOTE: See “Baking chart” earlier in this section or a reliable cookbook for temperature recommendations.

PRESS



YOU SEE



(example shows 375°F [191°C] temperature setting)

4. Press COOK TIME.

PRESS



YOU SEE





5. Set cook time.

PRESS

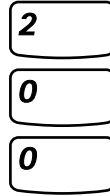

YOU SEE



(display shows 2-hour cook time)

6. Start oven.

PRESS



YOU SEE



7. When baking/roasting is done:

“End” will show on the display. Four tones will sound, followed by four short reminder tones every minute (unless the audible signals have been disabled), until you open the door or press CANCEL/OFF.

YOU SEE



To delay start and stop automatically:

1. Prepare oven.

Position the oven rack(s) properly and place the food in the oven. For correct rack placement, see “Rack positions” and the “Rack placement” chart earlier in this section.

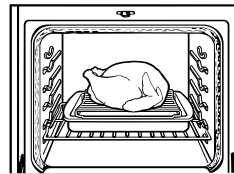

2. Choose Bake setting.

PRESS



YOU SEE



(or 177°C)

3. Set temperature (optional).

Do this step if you want to set a temperature other than the one displayed.

NOTE: See a reliable cookbook for temperature recommendations.

PRESS



YOU SEE



(example shows 375°F [191°C] temperature setting)



Using and Caring for Your Oven

4. Press **COOK TIME**.

PRESS



YOU SEE



5. Set cook time.

PRESS

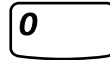
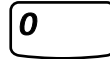
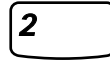

YOU SEE



(example shows 2-hour cook time)

6. Press **STOP TIME**.

PRESS



YOU SEE



7. Set stop time.

PRESS

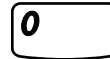
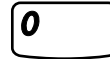

YOU SEE



(display shows stop time of 3:00)

8. Press **START**.

PRESS



YOU SEE



When start time is reached:

YOU SEE

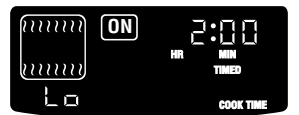



9. When baking/roasting is done:

“End” will show on the display. Four tones will sound, followed by four short reminder tones every minute (unless the audible signals have been disabled), until you open the door or press CANCEL/OFF.

YOU SEE



To cancel timed cooking settings:

Press CANCEL/OFF.

PRESS



YOU SEE

(display will go blank)

Cleaning your oven and controls

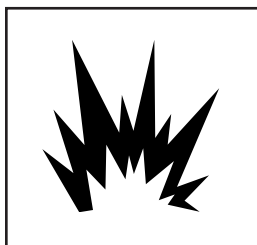

⚠ WARNING

Explosion Hazard

Do not store flammable materials such as gasoline near this appliance.

Doing so can result in death, explosion, or fire.

PART	WHAT TO USE	HOW TO CLEAN
Control knobs	Sponge and warm, soapy water	<ul style="list-style-type: none"> • Turn knobs to OFF and pull straight away from control panel. • Wash, rinse, and dry thoroughly. Do not soak. • Do not use steel wool or abrasive cleansers. They may damage the finish of the knobs. • Replace knobs. Make sure all knobs point to OFF.

continued on next page





Using and Caring for Your Oven

PART	WHAT TO USE	HOW TO CLEAN
Control panel	Sponge and warm, soapy water OR Paper towel and spray glass cleaner	<ul style="list-style-type: none"> • Wash, wipe with clean water, and dry thoroughly. • Do not use steel wool or abrasive cleansers. They may damage the finish. • Do not spray cleaner directly on panel. Apply cleaner to paper towel. <p>NOTE: Set the Control Lock to prevent the oven from accidentally turning on when you are cleaning the panel. (See “Using the control lock” earlier in this section.)</p>
Exterior surfaces (other than control panel)	Sponge and warm, soapy water	<ul style="list-style-type: none"> • Wash, wipe with clean water, and dry thoroughly. • Use nonabrasive, plastic scrubbing pad on heavily soiled areas. • Do not use abrasive or harsh cleansers. They may damage the finish.
Broiler pan and grid (clean after each use)	Steel-wool pad and warm, soapy water	<ul style="list-style-type: none"> • Wash, rinse, and dry thoroughly. • Do not clean in the Self-Cleaning cycle. See “Before you start” in the “Using the Self-Cleaning Cycle” section.
Oven racks	Steel-wool pad and warm, soapy water OR The Self-Cleaning cycle	<ul style="list-style-type: none"> • Wash, rinse, and dry thoroughly. <p>OR</p> <ul style="list-style-type: none"> • Leave in oven during Self-Cleaning cycle. <p>NOTE: Racks will permanently discolor and become harder to slide if left in oven during the Self-Cleaning cycle. Apply a small amount of vegetable oil to the side rungs to aid sliding.</p>
Oven door glass	Paper towel and spray glass cleaner OR Warm, soapy water and a nonabrasive, plastic scrubbing pad	<ul style="list-style-type: none"> • Make sure oven is cool. • Follow directions provided with the cleaner. • Wash, wipe with clean water, and dry thoroughly.
Oven cavity	Self-Cleaning cycle	<ul style="list-style-type: none"> • Wipe up food spills containing sugar as soon as possible after the oven cools down. (See “Using the Self-Cleaning Cycle” section.) • See “Using the Self-Cleaning Cycle” section.



Using and replacing the oven light(s)

Your oven may have a standard oven light or two side halogen lights. The oven light(s) will come on when you open the oven door. To turn the light(s) on when the oven door is closed, **press** the Oven Light pad  on the control panel. **Press** the pad  again to turn off the light(s).

Replacing the oven light (models with light on back wall):

1. **Unplug** range or **disconnect** power.
2. **Make sure** the oven is cool before replacing the light bulb.

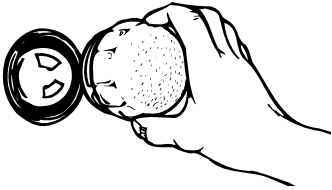

3. **Remove** the glass bulb cover in the back of the oven by turning it counterclockwise.
4. **Remove** the light bulb from its socket. **Replace** the bulb with a 40-watt appliance bulb.
5. **Replace** the bulb cover by turning it clockwise.
6. **Plug in** range or **reconnect** power.

NOTE: The oven light will not work during the Self-Cleaning cycle.

Replacing oven lights (models with side halogen lights):

1. **Unplug** range or **disconnect** power.
2. **Make sure** the oven is cool before replacing the light bulb.

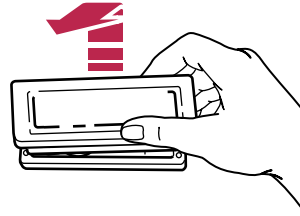

3. **Remove** glass light cover by grasping front edge of cover and pulling it away from the side wall of the oven.
4. **Remove** the light bulb from its socket. **Replace** the bulb with another halogen bulb (12 volt, 5 watt maximum, available at most hardware stores).
5. **Replace** the light cover by snapping it back into wall.
6. **Plug in** range or **reconnect** power.

NOTE: The oven lights will not work during the Self-Cleaning cycle.

Using the Self-Cleaning Cycle

The Self-Cleaning cycle saves you from the toil and mess that often come with hand-cleaning the oven interior. Like the other functions of your oven, you operate the Self-Cleaning cycle with the easy-to-use electronic control. To use this cycle properly, follow the step-by-step instructions in this section.



⚠ WARNING

Burn Hazard

Do not touch the oven during the Self-Cleaning cycle.
Keep children away from oven during Self-Cleaning cycle.
Do not use commercial oven cleaners in your oven.
Failure to follow these instructions can result in burns, or illness from inhaling dangerous fumes.

Before you start

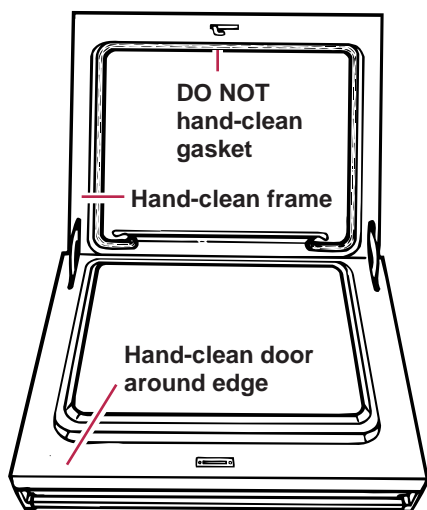

Before you start the Self-Cleaning cycle, make sure you:

- **Hand-clean the areas shown.** They do not get hot enough during the Self-Cleaning cycle for soil to burn away. Use hot water and detergent or a soapy, steel-wool pad for cleaning.
NOTE: DO NOT clean, move, or bend the gasket. Poor cleaning, baking, and roasting may result.
- **Remove** the broiler pan and grid and anything else being stored in the oven.

- **Wipe out** any loose soil or grease. This will help reduce smoke during the Self-Cleaning cycle.
- **Wipe up** food spills containing sugar as soon as possible after the oven cools down. When sugar is heated to a high temperature in the Self-Cleaning cycle, the high temperature can cause the sugar to burn and react with the porcelain. This can cause staining and etching or pitting.
- **Remove** the oven racks from the oven if you want them to remain shiny. You can clean racks in the Self-Cleaning cycle, but they will discolor and become harder to slide. If you clean racks in the Self-Cleaning cycle, place them on the rack guides.
- **Heat and odors** are normal during the Self-Cleaning cycle. Keep the kitchen well-ventilated by opening a window or by turning on a vent hood or other kitchen vent during the cycle.



NOTES:

- **Do not block** the oven vent during the Self-Cleaning cycle. Air must move freely for best cleaning results.
- **Do not leave** plastic utensils on the cooktop. They may melt.
- **Do not leave** any foil in oven during the Self-Cleaning cycle. Foil could burn or melt and damage the oven surface.
- **The oven light** will not work during the Self-Cleaning cycle.
- **The cooktop** will not work during the Self-Cleaning cycle on Canadian models.

Before setting the controls

- **Make sure clock is set to correct time of day.**
- **Make sure the oven door is completely closed.**

Setting the controls

To start cleaning immediately:

1. Press CLEAN.

A 3½-hour Self-Cleaning cycle will be set. (The first 3 hours are for cleaning, the last 30 minutes are for cooling.)

PRESS



YOU SEE



(display shows 3½-hour cleaning cycle)

2. Set cleaning time (optional).

If you want a Self-Cleaning cycle other than 3½ hours, **press** the desired Number pads for the new time up to 4½ hours.

- **Use** 2½ hours for light soil.
- **Use** 3½ to 4½ hours for moderate to heavy soil.

PRESS

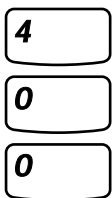

YOU SEE



(example shows 4-hour cleaning cycle)

3. Start oven.

NOTE: The door will lock right after you press START.

PRESS



YOU SEE



4. After the Self-Cleaning cycle ends:

YOU SEE





Using the Self-Cleaning Cycle

To delay cleaning start time:

1. Press CLEAN.

A 3½-hour Self-Cleaning cycle will be set. (The first 3 hours are for cleaning, the last 30 minutes are for cooling.)

PRESS



YOU SEE



(display shows 3½-hour cleaning cycle)

2. Set cleaning time (optional).

If you want a Self-Cleaning cycle other than 3½ hours, **press** the desired Number pads for the new time up to 4½ hours.

- Use 2½ hours for light soil.
- Use 3½ to 4½ hours for moderate to heavy soil.

PRESS

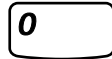
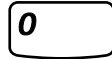

YOU SEE



(example shows 4-hour cleaning cycle)

3. Press STOP TIME.

PRESS



YOU SEE



4. Set stop time.

Example for 7:00:

PRESS

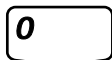
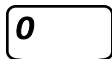
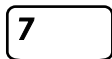

YOU SEE



(display shows stop time of 7:00)

5. Complete entry.

NOTE: The door will lock right after you press START.

PRESS



YOU SEE



When the start time is reached:

YOU SEE



6. After the Self-Cleaning cycle ends:

YOU SEE



To stop the Self-Cleaning cycle at any time:

PRESS



YOU SEE



(“DOOR LOCKED” will appear if oven has not cooled down)

For best cleaning results

- **After the oven cools to room temperature**, wipe up any residue or ash with a damp cloth or sponge. If any spots remain, clean with a mild abrasive cleanser or cleaning sponge.
- **Clean the oven** before it gets heavily soiled. Cleaning a very soiled oven takes longer and results in more smoke than usual.
- **If the Self-Cleaning cycle does not get the oven as clean as you expected**, the cycle may not have been set long enough or you may not have prepared the oven properly. Set the Self-Cleaning cycle longer the next time and hand-clean areas noted in “Before you start” earlier in this section.

How the cycle works

The Self-Cleaning cycle uses very high heat to burn away soil and grease. During the cycle, the oven gets much hotter than it does for normal baking or broiling. This high heat breaks up the soil or grease and burns it away.

Your oven is preset for a 3½-hour Self-Cleaning cycle. However, you can adjust the cycle time to the amount of soil in your oven. You can set the cycle anywhere between 2½ and 4½ hours. (See “Setting the controls” earlier in this section.)

The graph at the right is representative of a normal, 3½-hour Self-Cleaning cycle. Note that the heating stops after 3 hours, but it takes longer for the oven to cool enough to unlock the door.

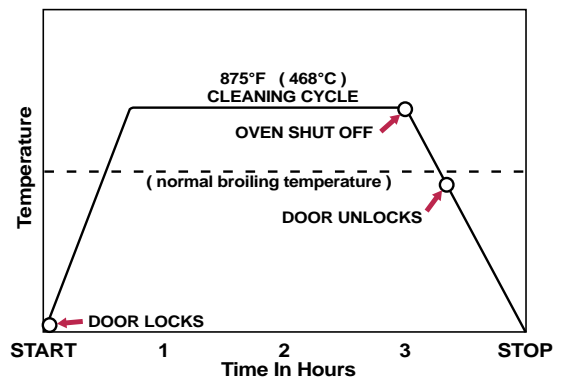

Troubleshooting

Most cooking problems often are caused by little things you can find and fix without tools of any kind. Check the lists below and on the next page before calling for assistance or service. If you still need help, see “Requesting Assistance or Service” on page 50 or 51.

If nothing operates, check the following:

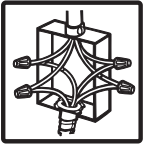

Is the range wired into a live circuit with the proper voltage?
(See Installation Instructions.)



Have you blown a household fuse or tripped a circuit breaker?



Other possible problems and their causes:

PROBLEM	CAUSE
The oven will not operate	<ul style="list-style-type: none"> You have not set the electronic control correctly. Refer to the section in this manual describing the function you are operating. You have programmed a delayed start time. Wait for the start time to be reached or cancel and reset the controls.
The surface cooking areas will not operate	<ul style="list-style-type: none"> You have blown a household fuse or tripped a circuit breaker. You have not set the control knobs correctly. Push control knobs in before turning to a setting.
The control knob(s) will not turn	<ul style="list-style-type: none"> You are not pushing in before turning.
The Self-Cleaning cycle will not operate	<ul style="list-style-type: none"> You have programmed a delayed start time. Wait for the start time to be reached or cancel and reset the controls.
Cooking results are not what you expected	<ul style="list-style-type: none"> The range is not level. (See Installation Instructions.) The oven temperature seems too low or too high. See “Adjusting the oven temperature” on page 33 to adjust oven temperature. You did not preheat the oven before baking (if called for in recipe).

PROBLEM	CAUSE
<p>Cooking results are not what you expected (continued)</p>	<ul style="list-style-type: none"> • You are using a pan that is not the correct type or size. Refer to a reliable cookbook or recipe for recommended pan type and size. • There is not enough air space around pan when baking. Allow 1½ to 2 inches (3.7 to 5 cm) of air space on all sides of pan. • The cookware is too large or too small for the surface cooking area being used. Pan should be the same size or slightly larger than the surface cooking area being used.
<p>The display is showing “PF”</p>	<ul style="list-style-type: none"> • There has been a power failure. Reset the clock. (See page 25.)
<p>A letter followed by a number shows on the display (for example “E3,” “F1”)</p>	<ul style="list-style-type: none"> • Press CANCEL/OFF. If the code does not disappear, call for service. (See Step 2 on page 50 or 51.)
<p>The key pads do not operate</p>	<ul style="list-style-type: none"> • The Control Lock has been set. (See “Using the control lock” on page 21.) Turn off the Control Lock by pressing and holding the Control Lock pad (Number Pad 3) for 5 seconds. • The Sabbath mode has been set (“SAb” appears on the display). Turn off the Sabbath mode by opening the oven door and pressing and holding Number Pad 6 for 5 seconds. • The range is not grounded. See Installation Instructions.

If none of these items was causing your problem, see “Requesting Assistance or Service” on page 50 or 51.

Requesting Assistance or Service

Before calling for assistance or service, please check the “Troubleshooting” section. It may save you the cost of a service call. If you still need help, follow the instructions below.

If you need assistance or service in the U.S.A.:

1. If the problem is not due to one of the items listed in the “Troubleshooting” section†:

- Call the KitchenAid Consumer Assistance Center:



1-800-422-1230

One of our trained consultants can instruct you in how to obtain satisfactory operation from your appliance or, if service is necessary, recommend a qualified service company in your area.

- If you prefer, write to:

KitchenAid Brand Home Appliances
Consumer Assistance Center
c/o Correspondence Dept.
2000 North M-63
Benton Harbor, MI 49022-2692

Please include a daytime phone number in your correspondence.

2. If you need service†:

- Call your dealer or the repair service he recommends.



- All service should be handled locally by the dealer from whom you purchased the unit or an authorized KitchenAid servicer.

- If you are unable to obtain the name of a local authorized KitchenAid servicer, call our Consumer Assistance Center telephone number (see Step 1).

† When asking for help or service:

Please provide a detailed description of the problem (including any information that appears on the electronic control display), your appliance’s complete model and serial numbers, and the purchase date. (See the “A Note to You” section.) This information will help us respond properly to your request.

Don’t forget, KitchenAid offers a full line of quality home appliances.

Built-In Refrigerators	Trash Compactors	Ranges & Cooktops
Freestanding Refrigerators	Hot Water Dispensers	Microwave Ovens
50-Pound Ice Makers	Food Waste Disposers	Washers & Dryers
Dishwashers	Built-In Ovens	Mixers & Blenders

For more information on these appliances, or the one you have purchased, call our toll free Consumer Assistance Center telephone number, **1-800-422-1230**.



If you need assistance or service in Canada:

1. If the problem is not due to one of the items listed in “Troubleshooting”† ...

Contact the dealer from whom you purchased your appliance, or call the KitchenAid Canada Consumer Assistance Centre toll free, **8:30 a.m. – 6 p.m. (EST)**, at **1-800-461-5681**.



2. If you need service† ...

Contact your nearest KitchenAid Canada Appliance Service branch or authorized servicing outlet to service your appliance. (See list below.)

† When asking for help or service: Please provide a detailed description of the problem, your appliance’s complete model and serial numbers, and the purchase date. (See the “A Note to You” section.) This information will help us respond properly to your request.

KitchenAid Canada Appliance Service – Consumer Services

Direct service branches:

BRITISH COLUMBIA		1-800-665-6788
ALBERTA		1-800-661-6291
ONTARIO (except 807 area code)	Ottawa area Outside the Ottawa area	1-800-267-3456 1-800-807-6777
MANITOBA, SASKATCHEWAN and 807 area code in ONTARIO		1-800-665-1683
QUEBEC	Montreal (except South Shore) South Shore Montreal Quebec City Sherbrooke	1-800-361-3032 1-800-361-0950 1-800-463-1523 1-800-567-6966
ATLANTIC PROVINCES		1-800-565-1598

For further assistance

If you need further assistance, you can write to KitchenAid Canada with any questions or concerns at:

Consumer Relations Department
KitchenAid Canada
1901 Minnesota Court
Mississauga, Ontario L5N 3A7

Please include a daytime phone number in your correspondence.

Index

This index is alphabetical. It contains all the topics included in this manual, along with the page(s) on which you can find each topic.

TOPIC	PAGE	TOPIC	PAGE
ANTI-TIP BRACKET	10	LOCK	
ASSISTANCE	50, 51	Control	21
BAKING		Self-cleaning cycle	45, 46
Aluminum foil	29	MODEL AND SERIAL NUMBER	3
Chart	30	OVEN TEMPERATURE	
Pans	28	Adjusting	33
Setting cycle	27	Setting	27, 33, 36, 38, 39
Tips	28, 29	PARTS	7, 8
BROILING		RACKS	
Broil Stop position	35	Placement	29
Chart	37	Positions	28
Grid	35	ROASTING	
Pan	35	Chart	32
Setting cycle	36	Setting cycle	27
Tips	37	Tips	31
CLEANING		SAFETY	4-6
Cooktop	15	SELF-CLEANING	
Oven	41-42	Delay cleaning	46
Self-cleaning	44	How cycle works	47
CONTROL PANEL		Preparing oven	44
Canceling	24	Setting controls	45, 46
Clock	25	Starting immediately	45
Command pads	17	Stopping cycle	47
Control lock	21	Tips	47
Display	17	SERVICE	50, 51
Fahrenheit/Celsius conversion	18	STORAGE DRAWER	
Number pads	17	Removing	9
Sabbath feature	22	Replacing	9
Signals	19	SURFACE COOKING AREAS	
Starting	24	Ceramic glass cooktop	12, 14, 15
Timer	25	Control knobs	11, 41
Tones	19	Control setting guide	11
COOKTOP		Dual-size surface cooking area	12
Caring for	14	Hot surface indicator lights	11
Cleaning	15	Power on lights	11
Using	11, 12	TIMED COOKING	
COOKWARE		Canceling	41
Canning	13	Cook time	38, 39, 40
Pans	13	Stop time	40
ENERGY SAVING TIPS	14	TROUBLESHOOTING	48-49
FEATURES	7, 8	WARRANTY	56
LIGHT(S)			
Oven	43		
Surface	16		

KitchenAid*

Electric Range

Warranty

LENGTH OF WARRANTY:	KITCHENAID WILL PAY FOR:	KITCHENAID WILL NOT PAY FOR:
ONE-YEAR FULL WARRANTY FROM DATE OF PURCHASE	Replacement parts and repair labor costs to correct defects in materials or workmanship. Service must be provided by an authorized KitchenAid servicing outlet.	A. Service calls to: <ol style="list-style-type: none"> 1. Correct the installation of the range. 2. Instruct you how to use the range. 3. Replace house fuses or correct house wiring. B. Repairs when range is used in other than normal home use.
SECOND-THROUGH FIFTH-YEAR LIMITED WARRANTY FROM DATE OF PURCHASE	Replacement parts for any electric element to correct defects in materials or workmanship. Replacement ceramic glass if breakage is due to defects in materials or workmanship. Replacement parts for solid state touch control system to correct defects in materials or workmanship.	C. Damage resulting from accident, alteration, misuse, abuse, fire, flood, acts of God, improper installation, or installation not in accordance with local electrical codes. D. Any labor costs during the limited warranties. E. Replacement parts or repair labor costs for units operated outside the United States and Canada. F. Pickup and delivery. This product is designed to be repaired in the home.
SECOND-THROUGH TENTH-YEAR LIMITED WARRANTY FROM DATE OF PURCHASE	Replacement parts for the porcelain oven cavity/inner door if the part rusts through due to defects in materials or workmanship.	G. Repairs to ceramic glass cooktop if it has not been cared for as recommended in this Use and Care Guide. H. Repairs to parts or systems resulting from unauthorized modifications made to the appliance. I. In Canada, travel or transportation expenses for customers who reside in remote areas.

9/97

KITCHENAID AND KITCHENAID CANADA DO NOT ASSUME ANY RESPONSIBILITY FOR INCIDENTAL OR CONSEQUENTIAL DAMAGES. Some states or provinces do not allow the exclusion or limitation of incidental or consequential damages, so this exclusion or limitation may not apply to you. This warranty gives specific legal rights and you may also have other rights which vary from state to state or province to province.

Outside the United States and Canada, a different warranty may apply. For details, please contact your authorized KitchenAid dealer.

If you need assistance or service, first see the "Troubleshooting" section of this book. After checking "Troubleshooting," additional help can be found by checking the "Requesting Assistance or Service" section. In the U.S.A., call our Consumer Assistance Center at **1-800-422-1230**. In Canada, call KitchenAid Canada at one of the telephone numbers listed in the "Requesting Assistance or Service" section.

KitchenAid
Benton Harbor, Michigan 49022-2692 U.S.A.

PART NO. 9752956

© 1997 KitchenAid

* Trademark of KitchenAid, U.S.A.,
KitchenAid Canada licensee in Canada

9/97
Printed in U.S.A.